

# CORRIM Company

## Corrosion Immune Fiberglass Doors & Frames

America's Premier Industrial Fiberglass Door and Frame System  
Will Never Rust — Guaranteed — Even In Highly Corrosive Environments

Serving the Architectural / Construction Industry for over 30 years

- Lifetime warranty against corrosion
- Urethane foam, end grain balsa, honeycomb or mineral core available
- Smooth, pebble or woodgrain face sheets available
- Polyurethane, prime or gelcoat finish available
- Completely sealed against the elements
- Chemical and salt resistant



- Beveled lock edge on active leaves
- Wide range of frames and hardware preps
- Unlimited design and application capabilities
- Tough, abuse resistant - passed 1 million cycle slam test
- Impervious to moisture, gasses and bacteria
- Ideal where FDA/USDA/OSHA regulations must be considered



UL approved 20 to 90 minute positive pressure FRP doors and FRP frames



Florida Building Code Approved  
Including HVHZ

### Specifically Designed For:

Animal Shelters

Car Washes / Marinas

Chemical Plants / Refineries

Clean Rooms

Detention Facilities

Food Processing

Hospitals

Offshore Platforms

Pharmaceuticals

Pools / Chlorine Rooms

Pulp / Paper Mills

Schools

Sports Facilities

Utilities

Veterinary Facilities

Waste Water Treatment Plants

Water Parks / Showers

Water Treatment Plants

YMCA's

Zoos / Aquariums



### CORRIM Company

Corrosion Immune Fiberglass Doors & Frames

Distributed By:

1870 Stillman Drive  
Oshkosh, WI 54901-1010

Phone: 920-231-2000 • Fax: 920-231-2238  
www.corrim.com • info@corrim.com



# CORRIM Fiberglass (FRP)

## Doors

### Typical Door Configurations

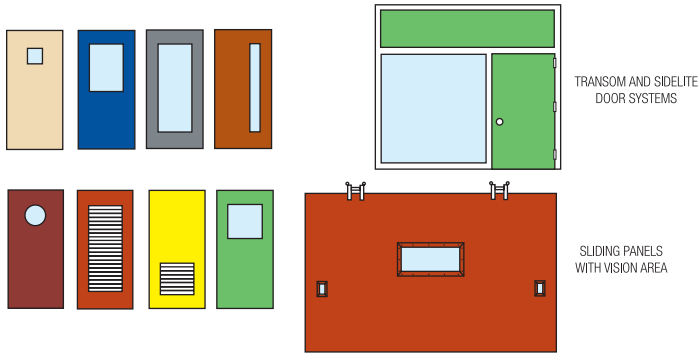

### Typical Construction Detail

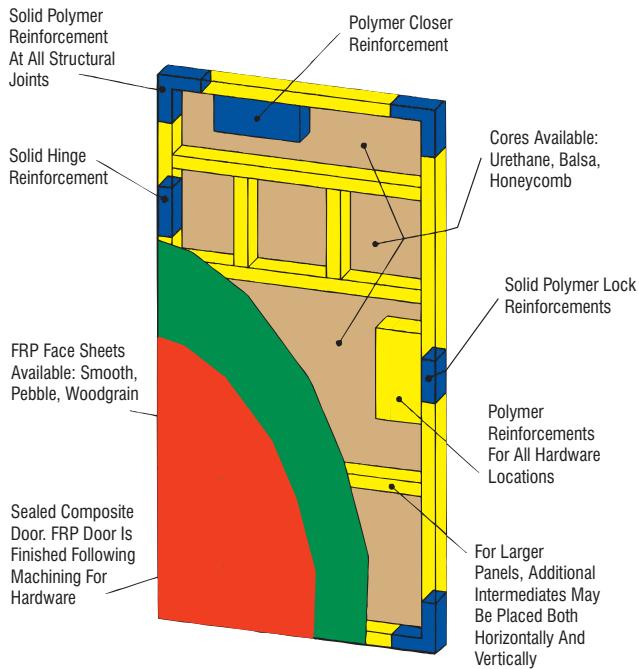

### Typical Door Glazing Options

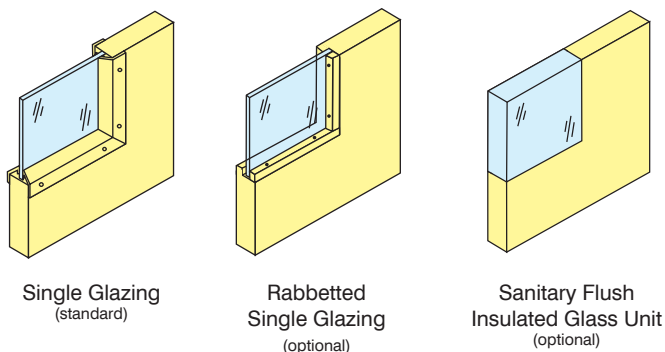

## Frames

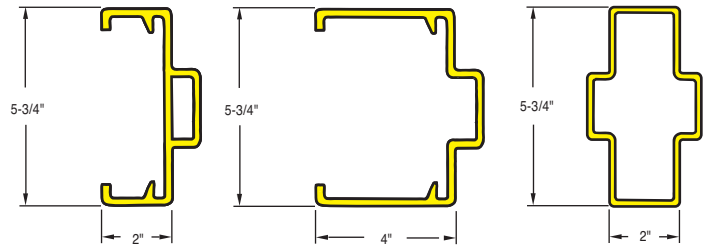

Standard Frames

### Modified Frames

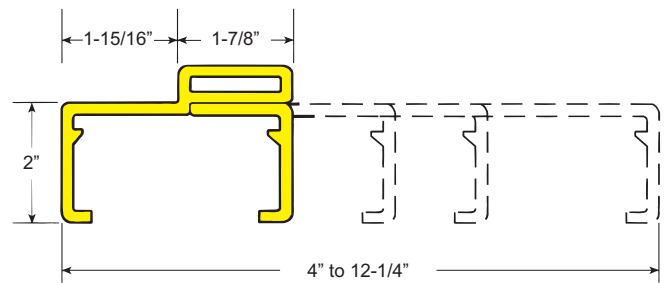

Contact factory for special frame depth sizes.

### Typical Frame Glazing Options

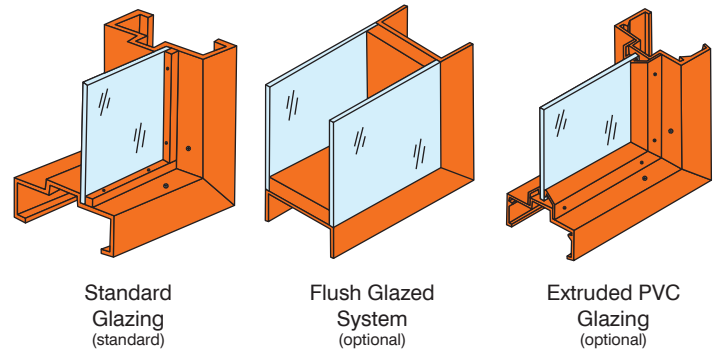

### Fixed Wall Lower

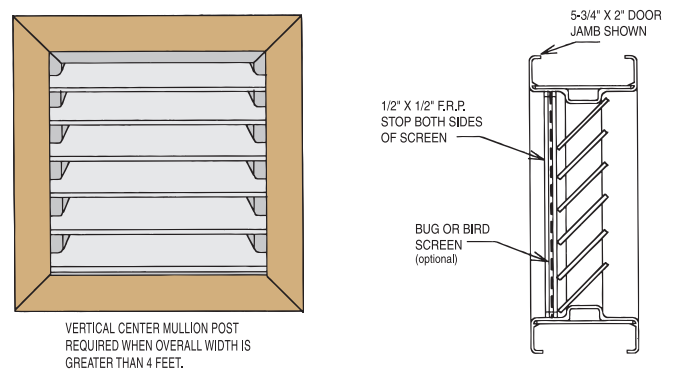

# UL Approved FRP Doors and FRP Frames

When a fire rating must be combined with corrosion resistance and security - Corrim fire doors and frames are ideal. The solid mineral core door, combined with structural FRP stiles and rails is totally sealed and impervious to the invasion of moisture, gases and bacteria.

Corrim's UL labeled FRP frames have the same strong, pultruded profile as our non-rated frames. Our light weight, hollow back frame does not require backfilling with grout — making installation a breeze. Multiple anchor options are available. As with all of Corrim's FRP products, our fire rated doors and frames come with a lifetime warranty against corrosion.

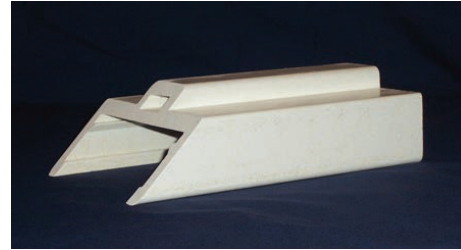
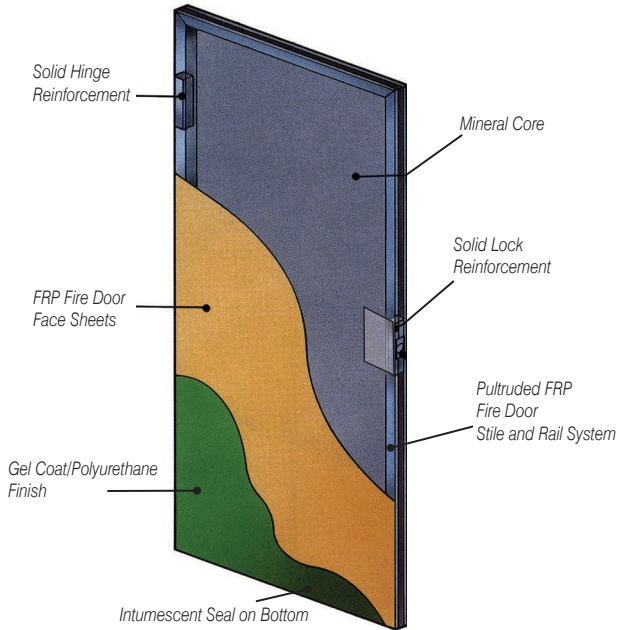

- 30, 45, 60 and 90 minute UL labels
- Passed ANSI/UL 1-1/2 hour fire, hose stream and positive, neutral/negative pressure tests
- Self-sealing against flames, smoke and fumes
- Passed the 250° temperature rise rating
- Singles up to 4-0 x 8-0
- Pairs up to 8-0 x 8-0
- Passed the slam and durability test per ANSI A151.1
- FBC (Florida Building Code) approved for single openings
- Intumescent seal applied to frame

## Available Anchors for UL Labeled FRP Frames

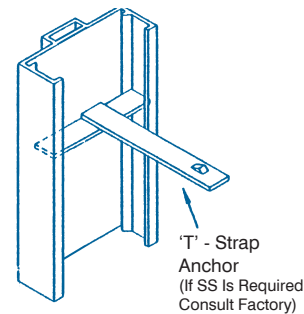
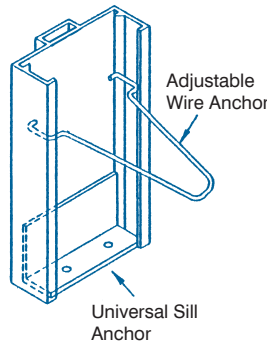
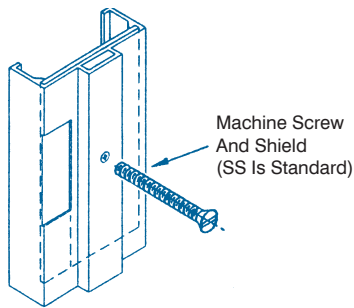

## Glazing Details for UL Labeled FRP Doors

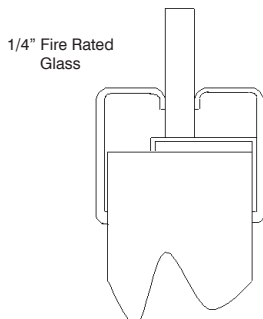

- Lites up to 100 square inches for 60 and 90 minute doors (larger sizes available without temperature rise rating)
- Lites up to 1296 square inches for 30 and 45 minute doors
- Fusible link louvers up to 24" x 24"

## Astragal Options for 90 Minute Rated Pairs

Astragals Required On 90 Minute Pairs With A Lock And Flushbolt Or Surface Bolts And Surface Vertical Rod/Mortise

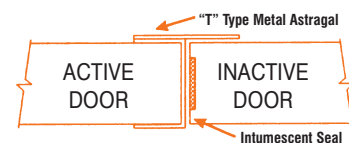

Astragals Required On 90 Minute Pairs With A Lock And Flushbolt Or Surface Bolts And Surface Vertical Rod/Mortise

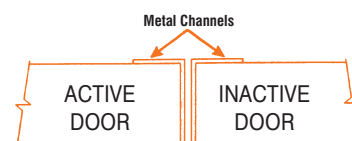

# CORRIM Company

## Standard Colors



WG-7000  
White



NG-74306  
Beige



AG-7505  
Standard Gray



LG-7053  
Blue

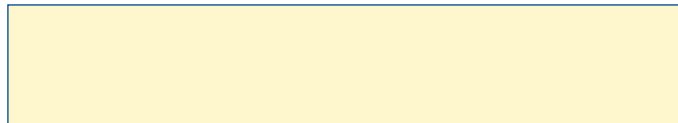

Polyurethane Primer (field painting by others)

## Optional Colors



UG-7160  
Light Yellow

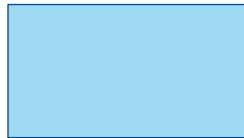

LG-70917  
Light Blue



GG-70618  
Aqua



LG-70097  
Royal Blue

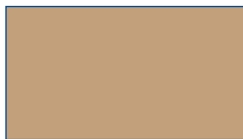

TG-7300  
Santa Fe Tan



YG-70064  
Burnt Orange



NG-7501  
Antique Brown

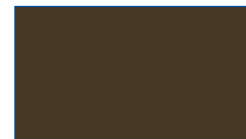

NG-99999  
Dark Brown



GG-70059  
Green



GG-70907  
Forest Green



RG-70666  
Brick Red



MG-70009  
Burgundy

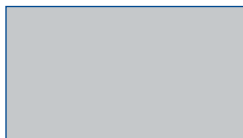

AG-72119  
Light Gray

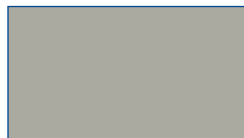

AG-71275  
Medium Gray



AG-7552  
Dark Gray

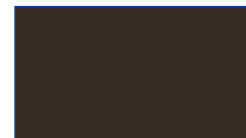

NG-74103  
Dark Bronze



RE-7074  
Safety Red



YG-70672  
Safety Orange



UG-7011  
Yellow



GG-71354  
Safety Green

CORRIM's standard is a matte or gloss polyurethane finish.  
A gelcoat finish available upon request.

Custom color matching is available.

All colors shown have been matched within limits of reproduction methods and actual color may vary.